

## FIXTURE INSTALLATION INSTALLATION DU LUMINAIRE

**Important:** Read all instructions in order to ensure safety and proper installation.  
*Lisez toutes les instructions afin d'assurer une bonne installation en toute sécurité.*

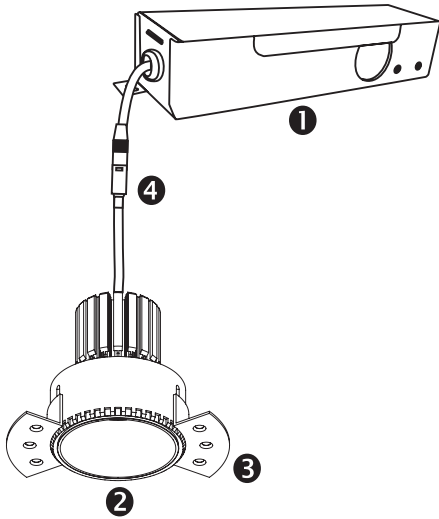







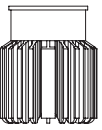

### PARTS LIST

- ❶ Junction box
- ❷ Modular Downlight / Trimless Downlight
- ❸ Spring clips
- ❹ Connector

### COMPATIBLE DIMMER LIST

Leviton: 6672 /6674

Lutron: CTCL-153P, DVCL-153P, S-600P, SLV-600P, CN-600P, DVWCL-153P, CTCL-153PR, DVCL-153PR.

Modular Model	Trim Model	Dimensions(DXL)	Specification	Power	Voltage	Cutout Size	Equivalent to	Application
 LRD-EGN-10W-XX	 LRD-WTR3PH-XX	Ø3-1/8"X4-1/8" (Ø79X103mm)	3" Modular COB LED Downlight	10W	120V AC / Triac Dimmable	Ø3" (Ø75mm)	75W Halogen	IC Rated
	 LRD-WTR3-XX	Ø3-1/4"X3-3/4" (Ø83X93mm)						
	 LRD-WTR3SL-XX	Ø3-1/8"X4-1/8" (Ø79X103mm)						
	 +  LRD-TLHR4 LRD-TLTR4-XX	5-1/2"X3-1/2"X4" (138X88X100mm)	4" Trimless Round Downlight	10W	120V AC / Triac Dimmable	Ø3-5/8" (Ø90mm)	90W Halogen	IC Rated
	 +  LRD-TLHS4 LRD-TLTS4-XX	5-1/8"X3"X4" (130X75X100mm)	4" Trimless Square Downlight	10W	120V AC / Triac Dimmable	3-1/2"X3-1/2" (86X86mm)	90W Halogen	IC Rated

## MAINTENANCE ENTRETIEN

- **Do not modify this fixture. Any modifications may render the product unsafe and void warranty.**  
*N'apportez pas de modifications à cet appareil. Toute altération risque de rendre l'appareil dangereux et d'annuler la garantie.*
- **This product is suitable for damp locations.**  
*Ce produit convient aux endroits mouillés.*

### Limited Warranty

The warranty applies to the product from the original date of purchase for five (5) years against manufacturing defects. The owner must provide a copy of the original proof of purchase. The manufacturer's obligation under this warranty is limited to repairing or replacing the component. It is not related in any way to the cost of the connection, the installation of the replacement parts or cost of transport.

### Garantie Limitée

Cette garantie limitée s'applique pour une période de cinq (5) ans suivant la date de l'achat par l'acheteur original. Une copie de la facture originale sera requise pour procéder avec toute demande. L'obligation du fabricant se limite à la réparation ou remplacement de l'unité. L'obligation de cette garantie ne comprend aucun frais d'installation ni des frais de transport.

## 3" Modular COB LED Downlight Installation Guide

**⚠ WARNING** Turn power OFF from electrical panel before installation or maintenance.

1. Turn power OFF from the electrical panel prior to installation.
2. Determine the location for installation and cut ceiling hole in accordance with cut-hole dimensions. Refer to Hole Diameter table for appropriate sizes. (Fig. 1)
3. Open the junction box cover and remove the appropriate knockout(s) on the side panel. (Fig. 2)
4. Insert the electrical supply cable through the knockout and secure with a cable connector (sold separately).
5. Using quick-connect push-in terminals, connect the ground wire to the green wire terminal; black wire to black wire terminal; white wire to white wire terminal. (Fig. 2)
6. Place all wiring and connections back in to the box and close the cover. Connect the driver to the light panel.
7. Insert junction box through the mounting hole. (Fig. 3)
8. Push spring-loaded clips on the fixture upwards and insert fixture base in to the mounting hole. Release the clips and fixture will be pulled flush to the ceiling. (Fig. 4)

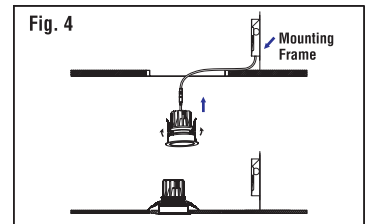
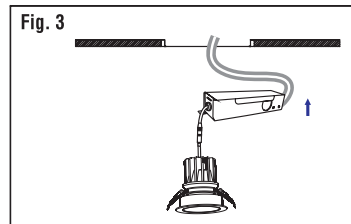
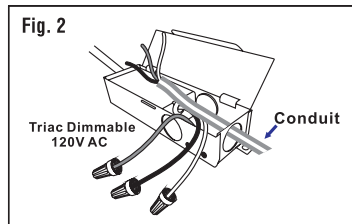
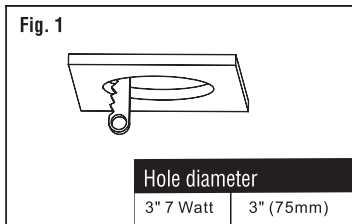

## 4" Trimless Downlight Installation Guide

### 1. How to put the lamp body into Built-in fitting ?

After putting the built-in fitting into the ceiling, in alignment with the position design, insert the lamp body into built-in fitting. Press the trim to lock with elastic terminal. ( Fig. 1)

### 2. How to take off lamp body from the built-in fitting ?

Only with a press to the trim on the lamp body, the elastic terminal will unlock, then can easily take out the lamp body from the built-in fitting. ( Fig.2)

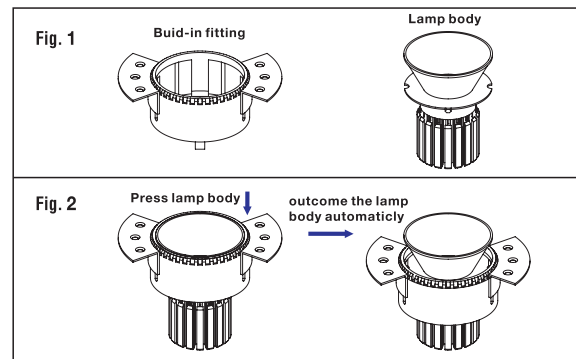

## Installation Manuals:

1. Determine the location for installation and cut ceiling hole in accordance with cut-hole dimensions. (Fig. 1)
2. Mounted the Built-in Fitting into the ceiling, screws to lock it. (Fig. 2)
3. Paint the ceiling 2 -3 times to make it smooth (Fig. 3)
4. Insert junction box through the mounting hole, connected all the wires on the junction box, connect the driver with the lamp body. Then press the trim to lock the lamp with the built-in fitting. (Fig. 4)
5. Turn on the light to test the light. (Fig. 5)

